



MMM Group

CLIMACELL[®] EVO

Climatic Chamber with Forced Air Circulation,
Cooling and Controlled Humidity



Innovative Heat Technology

MMM. Protecting human health.

Tradition, Quality, Innovation

Since its establishment in 1921, BMT Medical Technology s.r.o., the traditional manufacturer of medical and laboratory technology, has been gradually transformed from a small regional company to an international corporation.

In 1992, it became a member of the European MMM Group which has been operating on the world markets since 1954 as an important supplier of systems for the health care industry, science and research. With its comprehensive offer of products and services, sterilization and disinfection devices for hospitals, scientific institutes, laboratories and pharmaceutical industry, MMM Group has established itself as an outstanding quality and innovations producer on the global markets.

The knowledge and experience gained during the implementations of individual supplies for our customers all over the world, and the technical innovations have been permanently and positively influencing the development, construction and production of our devices. High level of our work has also been confirmed by the number of patents and industrial designs as well as an easy implementation of individual device adjustments.

MMM Group – excellence in medical and laboratory technology.

Basic Characteristics

Volume: 111, 222, 404, 707, 1212 litres
Working temperature: without humidity 0°C up to 100°C, with humidity: 10°C up to 90°C range up to 70°C for the volume of 1212 l
CLC EVO as optional equipment up to -20°C
CLC EVO as optional equipment of chamber decontamination up to 160°C (except for the 1212 litres volume)
Refrigerant: R513a, (or R134a) for -20 °C R449a
Cooling medium for generating the humidity: distilled water
Controlled humidity: 10% - 98% RH
Microprocessor controlled humidifying / dehumidifying system
CO₂ concentration: 0,2% up to 20% (optional equipment)
Inner glass door
Interior: stainless steel, mat. No. 1.4301 (AISI 304)

CLIMACELL® EVO

Climatic Chamber With a Wide Range of Applications

The device CLIMACELL® is designed for applications requiring exact and reproducible simulation of variable climatic conditions. The basic version of the incubator allows simultaneous regulation of temperature and humidity. In case of optional equipment buying, the device offers regulation of CO₂ respectively other gases concentration or space-homogenous lighting in the field of visible or UV light with adjustable intensity and possibility of intensity measuring using special probes. Thanks to the unique combination, the device offers a wide range of possible applications to users. CLIMACELL® can be used in biology, food processing, chemical industry, electrical technology, histology, botany, pharmacy and in other branches. As a typical example it is possible to state cultivation of plant and tissue cultures or stability (photo-stability) tests of materials and medicaments. Simple control via touch screen, exact regulation and many possibilities of data outputs meet the most demanding conditions of pharmaceutical industry and they also allow user-friendly simulation of simple requirements towards plants growing. Microprocessor-controlled system of humidification and dehumidification together with high-performance programmable system of exposure lighting guarantees excellent homogenous parameters for tests and growth conditions.

Maximum refrigerant safety without location restrictions

The CLIMACELL® and FRIOCELL® models now use an innovative refrigerant that meets the highest safety standards according to EN 378-1+A1 - it is non-flammable, does not form an explosive mixture in the event of a leak and is also non-toxic. Thanks to its classification in A1 safety group, the risk to the operator and the environment is minimal. This change brings the significant advantage of completely free placement of the device without the need for special technical modifications to the space. Our laboratory equipment thus offers not only top performance and precise temperature control, but also a new higher level of safety and lower operating requirements - the ideal choice for modern and responsible laboratories.

Meeting the requirements of regulations

2014/35/EU, 2014/30/EU, ICH 279/95 Option 2, FDA 21 Part 11, 2011/65/EU, 517/2014/EU, 573/2024/EU.



Applications



Pharmaceutical Industry

Stability testing and photo stability testing according to ICH 279/95 Option 2, long term storage.



Cosmetic Industry

Durability testing, testing of cosmetic products or primary materials stability.



Construction Industry

Long-term testing of quality and ageing of materials in construction industry - cement, paints, asphalt, construction plastics, glues, etc.



General and Applied Industry (research field)

E.g. cultivation of tissue cultures - human or animal ones.



Food and Beverage Industry

Testing of food quality under simulated transport or storage conditions - export of fruits, etc.



Packaging Material Industry

Long-term testing of packing technologies.

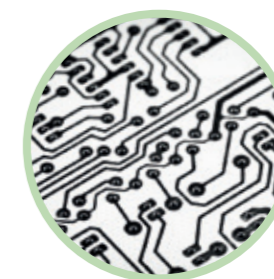

Electronic Industry

Durability testing of electronic boards.



Automotive Industry

Testing of materials ageing - tyres, sealing, etc.



Zoology

Simulation of conditions for sea organisms research, seaweed, cultivation of insect eggs, etc.



Botany

Studies of germination, green plants growing for further research.



Field of Metrology and Quality Control in Industry

Checking and calibration of industrial measuring gauges.

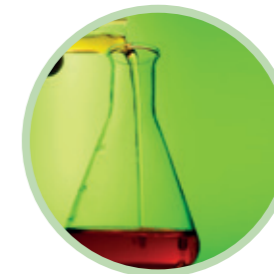

Chemical – Industrial

Fertilizers, pesticides, detergents, paint, oil, etc.



MMM Group



The New Control System Offers

- 5.7 inch (14.5 cm) touch screen display
- Microprocessor Fuzzy logic process control
- Intuitive control via colour icons
- Graphic configuration of a new program
- Transparent displaying of data course at the cycle
- Protective thermostat class 3
- Acoustic and visual alarm
- Multi-level users administration (corresponding to FDA 21 Part 11)
- Keyboard lock against unauthorised handling
- Data encryption and non-manipulability (corresponding to FDA 21 Part 11)
- Up to 100 programs and up to 100 segments for each program
- Yearly data logger in graphic and numeric form
- On-line or off-line data export
- Prepared service programs for fast diagnostics of faults
- Easy service diagnostics including remote access
- Multi-language communication
- Printing of protocols in PDF format via Warmcomm 4.0
- Easy user configuration of the device
- SD memory card, USB Host and RS 232 standardly included
- USB device or Ethernet interface with own IP address for remote data transfer, control and diagnostics (optional equipment)
- Programming of ramps, real time and cycling
- Fan setting 10–100%
- Main ON/OFF switch for security reasons
- Device state LED indicator

Connectivity

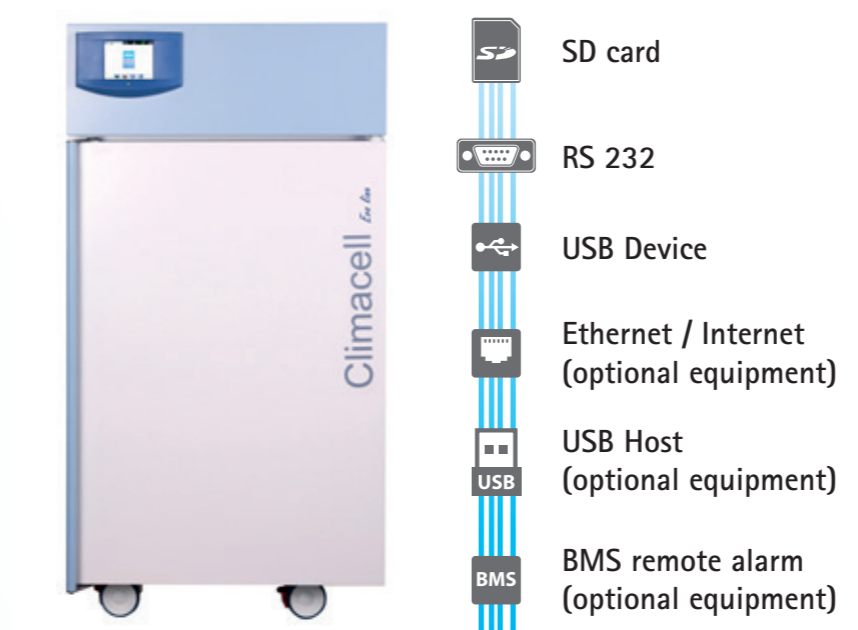

Data Outputs

Thanks to the most up-to-date components of electronic, the device CLIMACELL® EVO does not have any data peripherals connection limit. The basic configuration contains traditional and reliable RS 232, USB Device and the SD card as the data carrier. There is also available the USB Host for bi-directional USB communication and for remote connection there is the Ethernet (RJ 45) connection. Proper IP address allows easy connection to PC or selected printer, respectively other usual data periphery (Smartphone, Netbook, etc.). Thanks to the open platform and adjusted data format it is also possible to configure remote connection and to work with on-line data in remote mode (internet).



WarmComm 4.0

Universal Data Administration with Devices of the MMM Group



- Compatible with EVO line and ECO line devices
- Backward compatible with older heating technology series (Standard, Comfort - all except CO2CELL)
- Stable platform of the SQL library
- User-friendly environment
- Connection via Ethernet, RS 232 and USB
- Two-way communication – data monitoring and device control
- Client-Server architecture
- Three levels of the program depending on client's requirements (Basic-Professional-FDA)
- In compliance with FDA CFR 21 Part 11 (version F)
- Web support, on-line updating
- Protected licence policy
- Compatible with MS Windows XP / 7/8/10 operating systems
- Validation documentation IQ/OQ



Comfort Machine with Superior Parameters

MMM Group offers traditionally fully ranged size of the cabinet, from personal size 111 litres, up to new size 1212 litres, with the best ratio cost/performance. Patented vertical air flow with preheating chamber and asymmetrically perforated panels ensure the well proven vertical spiralled air flow with the best spatial homogeneity.

Deep experience of the factory engineers and many years of careful development help with sophisticated Fuzzy logic control system. By means of the Fuzzy logic are continually evaluated the current process conditions as size of chamber, set parameters, quantity of the samples inside and herewith optimizing heating, cooling and steaming performance.

High pressure steam generator in new easy accessible position and newly designed powerful freezing coil regulate the relative humidity quickly in full range from 10–98% RH, according the customer set, and without significant temperature interference.

Practical large and popular door handle, robust wheels with brakes and 220° (with exception of size 1212) openable main door(s) contributes to high user friendly character of the device. Light grey with light blue device colours highlighted by dark blue smiley control panel cause a pleasant feeling of harmony in the user every morning

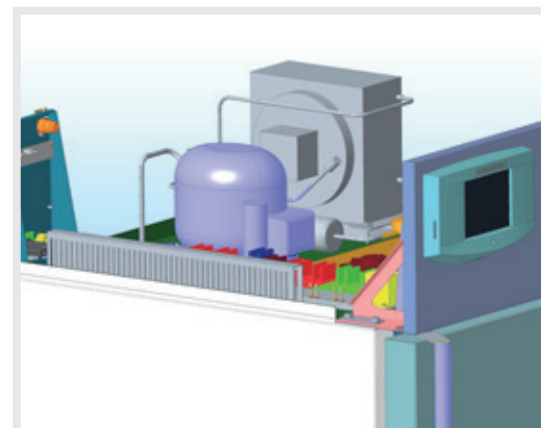
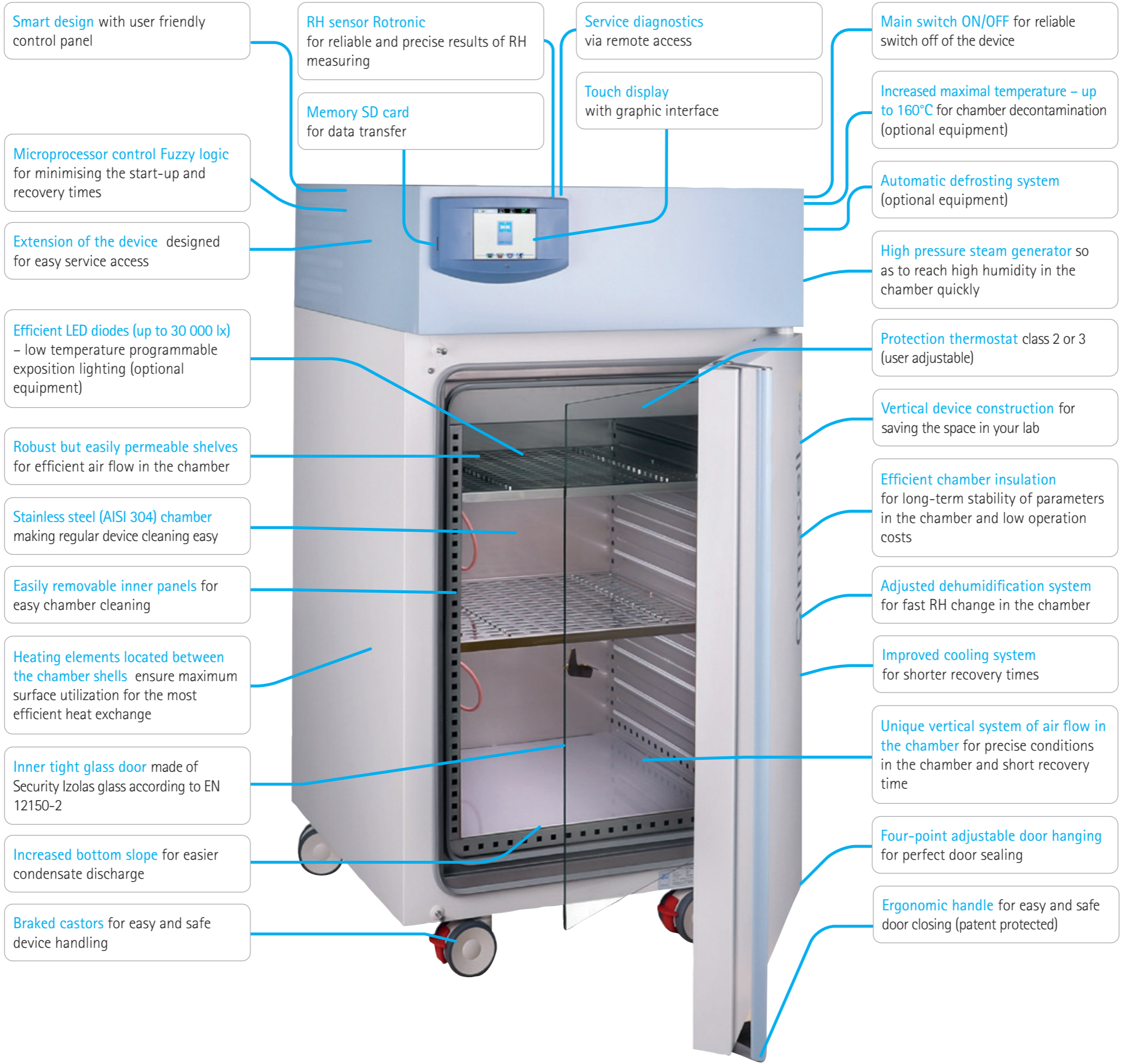

Programmable Exposure Lighting

New generation of the CLIMACELL® EVO device offers wide possibilities of selected lighting use. The variability of placement, selection of light sources, user friendliness and possibility of fluent intensity control meet even the most demanding requirements towards applications with exposure lighting.

Fluorescent Tubes in Doors

Traditional placement of the light case with new design and increased intensity of lighting (up to 36 000 lx). Exposure of the whole cross-section of the chamber with the lowest purchase costs and minimal influence on conditions in the chamber. Program-controlled switching on and off of the lighting for CLIMACELL® EVO. Program-controlled regulation of intensity within the range of 10-100% in increments of 1%, which can be completed with intensity measuring for CLIMACELL® EVO. Suitable for industrial simulation of materials ageing or undemanding processes of growth simulations. Simulation of day and night conditions. Available for CLIMACELL® EVO + CLIMACELL® EVO.

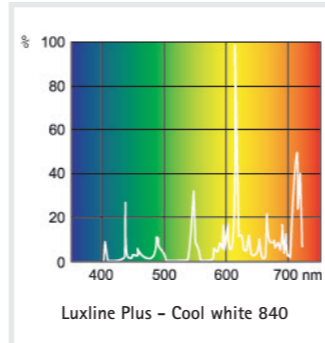

Fluorescent Tubes in Shelves

A vertical source of up to three light cases with direct lighting and variable height of lighting. Even lighting of the whole shelf and optimal use of the chamber volume for the area size lighting. Efficient balancing of temperature emissions thanks to perforation of cases and precise regulation of conditions in the chamber even under full lighting. Maximal intensity 23 000 lx (12 cm below the source). Program-controlled switching on and off of the lighting for CLIMACELL® EVO. Program-controlled regulation of intensity within the range of 10-100% in increments of 1%, which can be completed with intensity measuring for CLIMACELL® EVO. Typical for tests of photo-stability or basic growth simulations in botany. Simulation of day and night conditions. Available for CLIMACELL® EVO + CLIMACELL® EVO. Different colours of the light source.

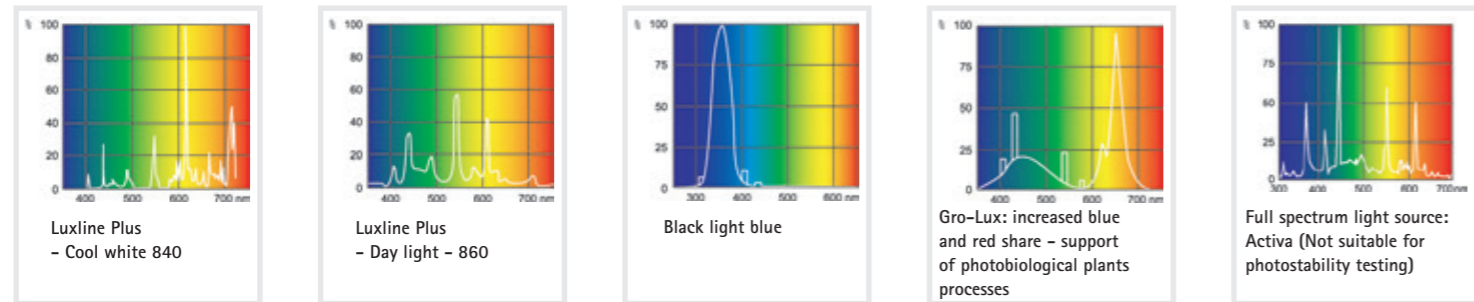

LED Lighting in the Door

Economic solution of white exposure LED lighting with higher intensity (up to 21 000 lx). Exposure of the whole cross-section of the chamber with low temperature emissions. Program-controlled switching on and off of the lighting for CLIMACELL® EVO. Program-controlled regulation of intensity within the range of 10-100% in increments of 1%, which can be completed with intensity measuring for CLIMACELL® EVO. Suitable for industrial testing with high demands towards intensity. Simulation of day and night conditions. May be completed with intensity measuring. Available for CLIMACELL® EVO + CLIMACELL® EVO.



White LED Lighting in Shelves

Precise horizontal lighting with white or colour LED lighting with maximal intensity (up to 30 000 lx), low temperature emissions of the light source, variability of enlightened cases placement. Program-controlled switching on and off of the lighting for CLIMACELL® EVO. Program-controlled regulation of intensity within the range of 10-100% in increments of 1%, which can be completed with intensity measuring for CLIMACELL® EVO. It is suitable for industrial use or use in botany. Maximal use of enlightened surface of shelves in relation to the chamber volume. Simulation of day and night conditions. May be completed with intensity measuring. Available for CLIMACELL® EVO + CLIMACELL® EVO.



Humidity Control

CLIMACELL® EVO is a climatic chamber – i.e. a device that is able to exactly and quickly regulate the quantity of humidity in the chamber. This is possible thanks to strong system of active increase and decrease of humidity in connection with the system of water supply to the device.

Steam Generator

The device allows steam generation and its precise dosing to the chamber. Thanks to our long-term experience in the field of steam sterilisation we succeeded to develop pressure steam generator able to increase relative humidity in the chamber in a precise, reliable and fast way. Steam overpressure is generated in the water reservoir using the heating element. Then, the valve releases exact volume of steam to the chamber. The technology eliminates the overshootings while reaching required level of relative humidity.

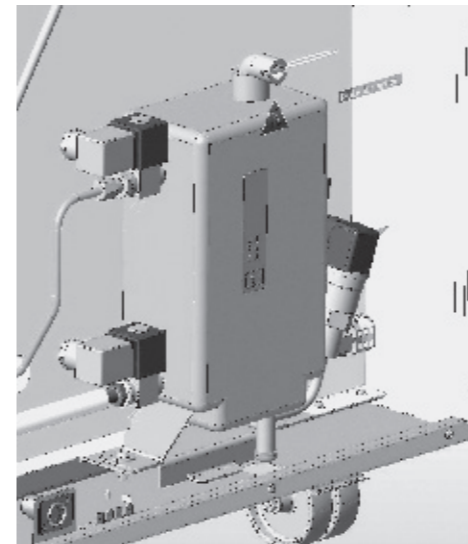

Humidity Reduction

Unlike many other manufacturers we are not engaged only in humidity increase, but we also focus on active humidity decrease, using the separate cooling snake of the cooling system. The control system of CLIMACELL® EVO is able to reduce humidity in the chamber using the cooling system while keeping a nearly constant temperature. Humidity condensates on



freezing element and condensed water is drained back to the waste receptacle, being pumped to the drain from there. Thanks to the efficient system CLIMACELL® EVO reaches even the low relative humidity values very quickly.



Water Intake and Use

In order to create the humidity exactly and reliably in the long term, the steam generator of CLIMACELL® EVO operates only with demineralized water. The access to such water can be solved in two ways. A standard solution means that you pour demineralized water to a barrel, delivered with each CLIMACELL® EVO and you connect the pump from the barrel to the connector on the rear side of the device. The other possibility includes connection of demineralized water intake from the laboratory water distribution system to the steam generator of CLIMACELL® EVO via reduction pressure valve. In both cases, the device automatically takes exact quantity of water as needed for humidity creation in the steam generator.



Restrictions of Temperature and Relative Humidity Setting Combinations

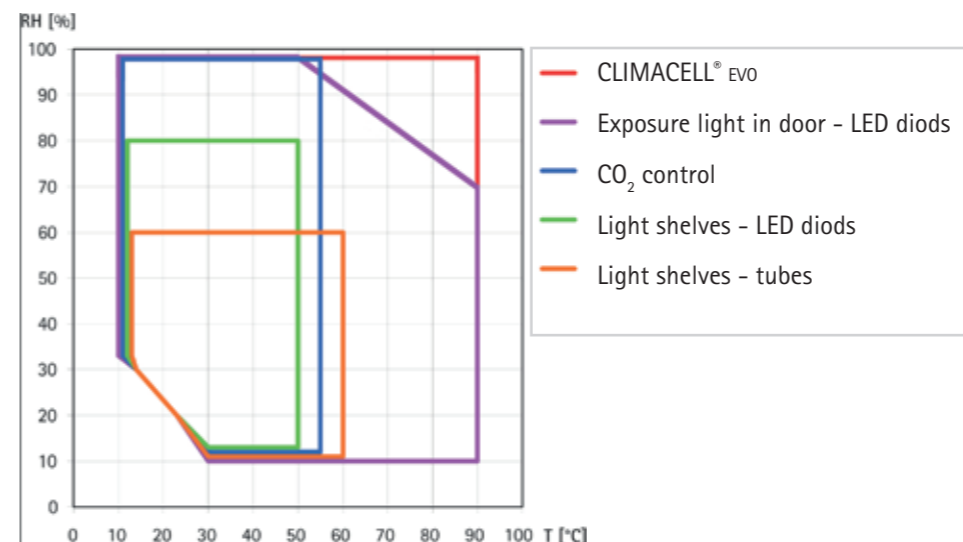

Accessories Included

Each CLIMACELL® EVO is supplied with standard equipment which does not have to be additionally ordered and it makes a standard part of delivery:



Touch screen

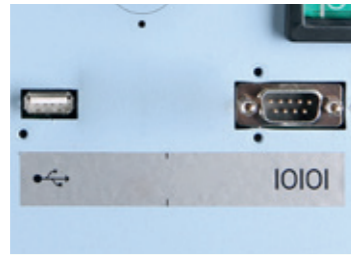

Communication ports RS 232 and USB host



SD card

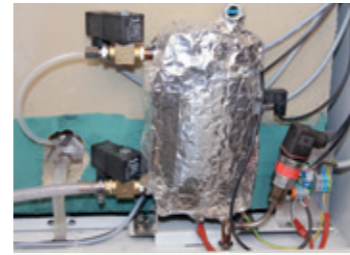

Steam generator, humidity control



Water barrel for demineralized water



Reliable RH sensor



Multi-conductor temperature sensor



Sealing inner glass door

Optional Equipment

Thanks to modular construction of our devices even CLIMACELL® EVO may be additionally equipped according to your preferences with many additional options. CLIMACELL® EVO may then serve as a chamber for testing of photo-stability, light simulation of day and night, processes with CO₂ control, hot-air decontamination, etc.

- Hot-air decontamination 160°C
- Additional cooling -20°C
- Flexible temperature sensors
- LED light shelves
- Exposure lighting in doors
- Light sensors of exposure
- Defrosting system
- CO₂ control
- Software WarmComm 4,0
- Data module USB device, Ethernet, wi-fi
- Mechanic door lock
- Electromagnetic door lock
- Trays or shelves
- Access port Ø 25, 50, 100 mm
- Programmable inner socket
- External printer
- Multi-point temp. / humidity measuring
- IQ/OQ protocols

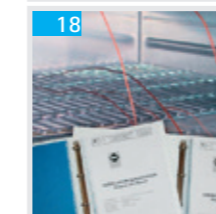
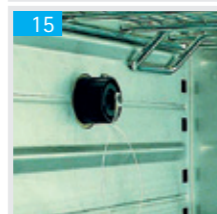
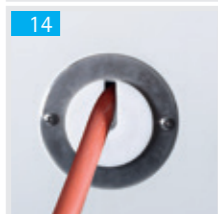
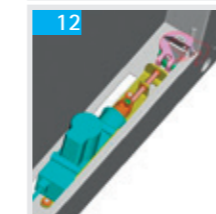
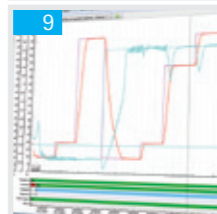
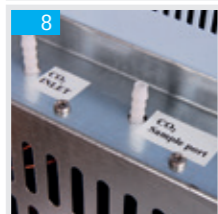
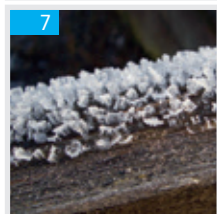
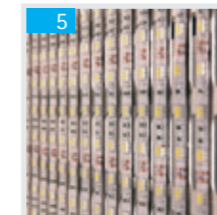
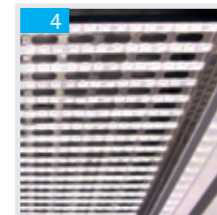

Technical Parameters

CLIMACELL® EVO (CLC EVO) 111, 222, 404, 707, 1212								
Technical data Internal space - chamber, stainless steel DIN 1.4301 (AISI 304)	volume	Approx. l	111	222	404	707	1212	
	width	mm	540	540	540	940	3x540	
	depth	mm	380	530	530	530	530	
	height	mm	535	765	1415	1415	1415	
Volume of the steam space	Approx. l	167	305	530	878	1753		
External dimensions (including door, handle and caster)	width	mm	780	780	1100	1500	2530	
	height (incl. caster)	mm	1187	1450	1890	1890	1921	
	depth	mm	755	885	885	885	898	
Package - dimensions	width	Approx. mm	992	1120	1332	1682	2742	
	height (incl. palette)	Approx. mm	1650	1746	2200	2190	2240	
	depth	Approx. mm	954	952	1062	1064	1137	
Weight CLC EVO 0°C	net	Approx. kg	110	143	240	280	541	
	brut	Approx. kg	220	263	390	500	861	
Weight CLC EVO -20°C	net	Approx. kg	120	153	250	290	567	
	brut	Approx. kg	230	273	400	510	887	
Shelves of stainless steel *	shelves	max. No.	7	10	19	19	3x19	
	standard equipment	pcs. included	2	2	2	2	6	
	min. distance between shelves	mm	70	70	70	70	70	
	Storage area (w x d)	mm	520x335	520x485	520x485	920x485	520x485	
Maximal load *)	per 1 tray	kg/screen	20	30	30	50	30	
	for a shelf	kg/shelf	20	30	30	20	30	
	total inside of device	kg/case	50	70	100	130	300	
Number of outer metal doors	psc.	1	1	1	2	3		
Number of inner glass doors	psc.	1	1	1	2	3		
Electricity	max. power	W	2000/2200**	2200/2300**	2700/2700**	3000/3050**	3500/4300**	
	mains 50/60 Hz	V	115/230	115/230	115/230	115/230	115/230	
IP Code			IP 20	IP 20	IP 20	IP 20	IP 20	
Temperature data	from 0°C	to °C	100 (decontamination 160 °C)				70	
Working temperature	from -20°C	to °C	100 (decontamination 160 °C)				70	
Temperature accuracy	in space at 10°C	Approx. (±) °C	<0,5	<0,5	<1	<1	<0,9	
	at 37°C	Approx. (±) °C	<0,5	<0,5	<1	<1	<0,5	
	in time	Approx. (±) °C	<0,2	<0,2	<0,3	<0,4	<0,2	
Heating/up time to 37°C from the ambient temperature	min		<11	<11	<13	<13	<30	
Cooling/down time from 22°C to 10°C	0 °C	min	<21	<17	<19	<21	<21	
	-20 °C	min	<11	<14	<21	<22	•	
Recovery time after 30 s of door opening according to DIN 12 880	při 37 °C	min	<4	<3	<3	<6	•	
	při 50 °C	min	<5	<6	<7	<6	•	
Relative humidity CLC EVO	range	%	10-98	10-98	10-98	10-98	10-98	
Accuracy RH (T _{chamber} ≥ 21°C)	in time	%	< 2	< 2	< 2	< 2	< 2	
Heat emission	at 37°C	Approx. W	70	63	123	148	200	
Complete device noise level		dB	46/52	50/56	56/58	58/65	60	
CO₂ concentration		%	0,1-20				-	0,1-20
Required pressure CO₂		bar/psi	0,3-0,7/5-10				-	0,3-0,7/5-10

Note: All technical data are related to 22°C ambient temperature .

• not measured

*) Approx. 50% of the tray area can be filled in a way a uniform air circulation is enabled inside the chamber.

***) Value at cooling up to -20°C.

The values may differ depending on specific charge and media parameters.

Change in the design and make reserved.

Make Acquaintance With Our Further Offers ...

Unique Line... Cell



Designation	Type marking	Laboratory case type	ECO line		Natural air circulation	Forced air circulation	Temperature range in °C (Optional equipment)	Volume 22 (l)	Volume 50 (l)	Volume 55 (l)	Volume 111 (l)	Volume 190 (l)	Volume 222 (l)	Volume 404 (l)	Volume 707 (l)	Volume 1212 (l)	
			EVO line	Line Standard Linie Comfort													
drying, tempering, sterilization	ECOCELL®	drying oven	•		•		5*-250/300	•		•	•		•	•	•		
	DUROCELL	drying oven with protective layer of inner space EPOLON	•		•		5*-125	•		•	•		•				
	VENTICELL®	drying oven	•			•	10*-250/300	•		•	•		•	•	•	•	•
	STERICELL® ***	hot-air sterilizer	•			•	10*-250	•		•	•		•	•			
	VACUCELL®	drying oven with vacuum	•				5*-250/300	•		•	•						
incubation	INCUCELL®	incubator / biological thermostat	•		•		5-100	•		•	•		•	•	•	•	•
	INCUCELL® V	incubator / biological thermostat	•		•		10-100	•		•	•		•	•	•	•	•
	FRIOCELL®	incubator with cooling	•			•	0-100 (-20)			•	•		•	•	•	•	•
	CLIMACELL®	incubator with cooling and controlled humidity	•			•	0-100 (-20)			•	•		•	•	•	•	•
	CO2CELL**	incubator with CO ₂ atmosphere		•	•		5*-60		•			•					

* above the exterior temperature

** manufacturer MMM Medcenter Einrichtungen GmbH, Semmlweisstrasse 6, D-82152 Planegg / Munich, tel.:+49 89 89 92 26 20, e-mail: medcenter@mmmgroup.com

*** the STERICELL® line also meets European Directive 2017/745 (MDR) for medical devices



Make acquaintance with our further offers...



VENTICELL® IL depyrogenation cabinets



Steam sterilizers



Steam sterilizers



Hot-air sterilizers



youtube.com/bmtbrno



facebook.com/bmt.cz



MMM Medcenter Einrichtungen GmbH, Semmlweisstrasse 6, D-82152 Planegg / München
Tel.: +49 89 8992 2620, Fax.: +49 89 8992 2630, E-mail: medcenter@mmm-medcenter.de, www.mmm-medcenter.de

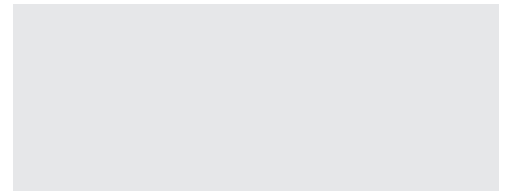

CLIMACELL Evo_05/2025_EN/PR

TLP: CLEAR